

# TOPLA STARTER BATTERIES

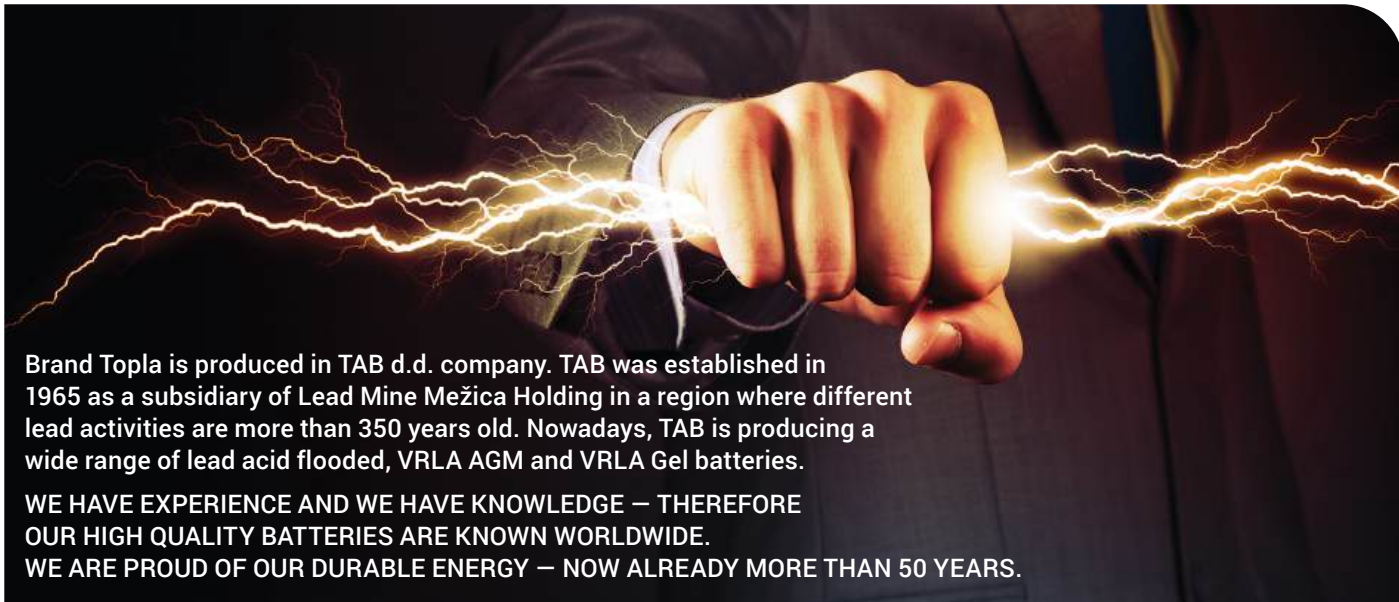

topla

TOPLA ENERGY  
TOPLA TOP  
TOPLA TOP JIS  
TOPLA ENERGY TRUCK  
TOPLA TOP TRUCK  
TOPLA EFB Stop & Go  
TOPLA AGM Stop & Go



Brand Topla is produced in TAB d.d. company. TAB was established in 1965 as a subsidiary of Lead Mine Mežica Holding in a region where different lead activities are more than 350 years old. Nowadays, TAB is producing a wide range of lead acid flooded, VRLA AGM and VRLA Gel batteries.

**WE HAVE EXPERIENCE AND WE HAVE KNOWLEDGE – THEREFORE OUR HIGH QUALITY BATTERIES ARE KNOWN WORLDWIDE. WE ARE PROUD OF OUR DURABLE ENERGY – NOW ALREADY MORE THAN 50 YEARS.**

TAB Tovarna Akumulatorskih Baterij d. d., Polena 6, SI-2392 Mežica, Slovenia | info@tab.si | +386 (0)2 8702 300 | www.tab.si

# ENERGY IN MOTION

## EMS TRUCK BATTERIES

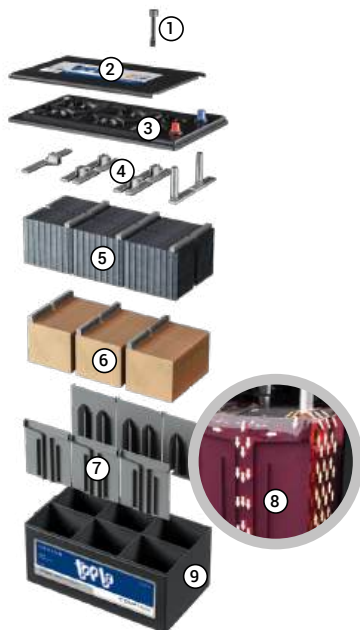

- 1 Electrolyte level indicator – Magic Eye
- 2 Top SMF lid with central degassing and flame arrestors (Battery manufactured by using Sb/Ca technology is fitted with a Flat lid with M27 plugs, for easy access)
- 3 Main SMF lid with labyrinth for additional safety and very low water loss
- 4 Robust plate connectors with large surface inter cell welds, increasing cranking power
- 5 Negative plate with additives for increased charging abilities. Permanent sulfation is severely restricted
- 6 Positive plates with thick casted grids. High-density active mass increases cycle life plus enhanced resistance to deep discharge
- 7 Integrated flexible ribs which generate adequate pressure to the plate stack in all states of charge
- 8 New cell design promotes acid motion in vertical direction, eliminating stratification
- 9 Impact resistant polypropylene container

## Allowable shelf life (SELFDISCHARGE)

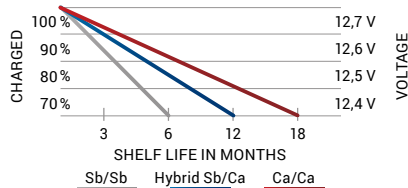

## Water consumption (g/Ah)

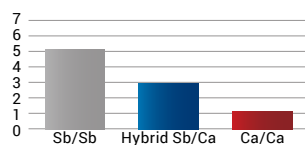

## Layout

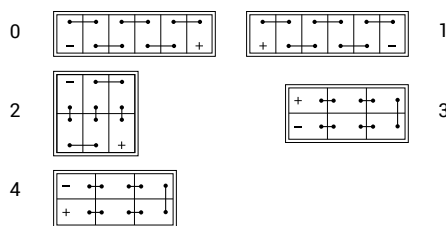

## Glossary of remarks

- K** Kamina
- H** Handle
- KH** Kamina Handle
- ME** Magic Eye
- HD** Heavy Duty
- JIS** Japanese Poles
- P** Post Poles
- SMF** Maintenance Free = Sealed
- DP** Dual Poles
- A** Pole Adapter
- AGM** Absorbed Glass Mat
- EMS** Electrolyte Mixing System
- S** Stud Poles

## Base hold down

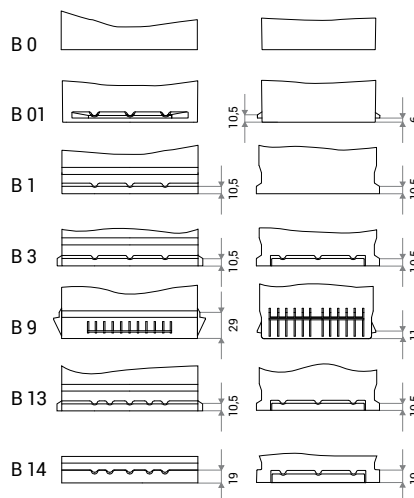

## Terminals

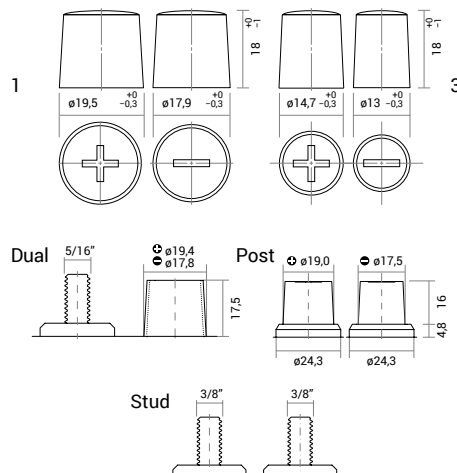

**TOPLA ENERGY** is a battery produced using Ca/Ca expanded metal technology designed for vehicles with entry level of electric equipment with demand of superior starting, performance and reliability. Topla Energy is real all rounder offering excellent power, capacity, cold start performance and reliability. This is high quality product for vehicles of every class.

- + High starting capabilities
- + Reliable starting at extreme climatic conditions



## TOPLA ENERGY

Flooded starter batteries, Ca/Ca technology | CAR batteries

ID	DIN marking	Short code	C20 (Ah)	RC (min)	Box type	EN (A)	LxWxH (mm)	BHD	Layout	Weight (kg)	PCS/Pallet (EUR/CNT)	Remarks
108845	54506	E45H	45	71	L0	400	175x175x190	B13	0	10,5	72/120	K, B
108044	54002 SMF	TS40	40	62	L1B	360	207x175x175	B13	0	10,7	72/120	SMF, H, B
108045	54502	E45	45	71	L1B	420	207x175x175	B13	0	11,2	72/120	KH
108345	54403 SMF	E45X	45	71	L1B	420	207x175x175	B13	1	10,7	72/120	SMF, H, B
108050	55010	E50H	50	81	L1	450	207x175x190	B13	0	12,2	72/100	KH
108054	55509	TS54	55	90	L2B	500	242x175x175	B13	0	13,3	63/108	KH
108060	56008	E60H	60	100	L2	600	242x175x190	B13	0	14,4	63/90	KH
108160	56265	E60X	60	100	L2	600	242x175x190	B13	1	14,4	63/90	KH
108066	56649	E66H	66	112	L2	620	242x175x190	B13	0	15,0	63/90	KH
108073	57309	E73	73	126	L3B	630	278x175x175	B13	0	15,9	51/80	SMF, H, HD, B
108266	56638 SMF	S66H	66	112	L3	600	278x175x190	B13	0	16,1	51/80	SMF, H, HD, B
108275	57412	E75	75	130	L3	750	278x175x190	B13	0	17,2	51/80	KH, HD
108375	57413 SMF	E75X	75	130	L3	750	278x175x190	B13	1	17,2	51/80	SMF, H, HD, B
108000	59249	E100V	100	182	L4	800	315x175x190	B13	0	20,0	42/60	KH, HD, B
108092	59220	E92	92	165	L5B	800	353x175x175	B13	0	20,5	36/72	KH, HD
108192	59221 SMF	E92X	92	165	L5B	800	353x175x175	B13	1	20,5	36/72	SMF, H, HD, B
108400	60044	E100H	100	182	L5	900	353x175x190	B13	0	22,5	36/60	KH, HD
108210	61002	E11H	110	203	L6	1000	394x175x190	B13	0	24,7	36/60	KH, HD, B

## ENERGY IN MOTION



## TOPLA ENERGY TRUCK

Flooded starter batteries, Sb/Ca technology | TRUCK batteries

ID	DIN marking	Short code	C20 (Ah)	RC (min)	Box type	EN (A)	LxWxH (mm)	BHD	Layout	Weight (kg)	PCS/Pallet (EUR/CNT)	Remarks
177110	61028	ET11	110	203	60528	800	345x172x218/238	B0	0	26,5	36/48	H
177410	61028	ET11P	110	203	60528	800	345x175x218/238	B1	0	26,5	36/48	H
167912	61044	ET11M	110	203	MAC 110	720	509x175x182/208	B3	3	31,1	24/40	H, HD
108910	62047	ET12	120	225	60528	900	345x172x218/238	B0	0	27,8	36/48	H
177125	62512	ET12H	125	235	62512	800	345x172x269/289	B0	0	31,8	24/36	H
177235	63512	ET13H	135	257	62512	800	345x172x269/289	B0	0	31,8	24/36	H
952912	63530	ET13A	135	258	A	850	513x189x194/220	B0	3	35,6	24/35	H, HD
163912	63544	ET13M	135	258	MAC 110	850	509x175x182/208	B3	3	33,3	24/32	H, HD
953912	63545	ET13MR	135	258	MAC 110	850	509x175x182/208	B3	4	33,3	24/32	H, HD
954912	64323	ET14M	143	276	MAC 143	900	509x216x184/210	B3	3	38,7	21/35	H, HD
155913	64518	ET14B	145	280	B	900	512x222x194/221	B0	3	39,6	21/28	H, HD, EMS
164912	65048	ET15M	150	292	MAC 110	1000	509x175x182/208	B3	3	36,9	24/32	H, HD
156913	68032	ET18	180	361	B	1100	512x222x194/221	B0	3	43,3	21/28	H, HD, EMS
159913	69032	ET19	190	385	B	1200	512x222x194/221	B0	3	43,3	21/28	H, HD, EMS
160913	70032	ET20B	200	409	B	1200	512x222x194/221	B0	3	45,0	21/28	H, HD, EMS
956912	70027	ET20C	200	409	C	1200	518x273x214/241	B0	3	52,7	18/24	H, HD, EMS
957912	72527	ET22	225	469	C	1300	518x273x214/241	B0	3	56,1	18/24	H, HD, EMS
104712	6TN	EN11D7	110	203	D7	740	282x269x208/230	B0	2	30,8	24/36	H, HD



## TOPLA TRUCK



## TOPLA TOP TRUCK

Flooded starter batteries, Ca/Ca technology | TRUCK batteries

ID	DIN marking	Short code	C20 (Ah)	RC (min)	Box type	EN (A)	LxWxH (mm)	BHD	Layout	Weight (kg)	PCS/Pallet (EUR/CNT)	Remarks
243612	63544 SMF	TT13M	135	258	MAC110	850	509x175x196/223	B3	3	33,3	24/40	SMF, ME, H, HD
231612	64030 SMF	TT14	140	269	A	850	507x188x200/228	B0	3	35,6	24/35	S M F , M E , H , H D
216612	65048 SMF	TT15M	150	292	MAC110	1000	509x175x196/223	B3	3	36,9	24/40	S M F , M E , H , H D
436612	65018 SMF	TT15	150	292	B	950	513x222x194/221	B0	3	39,6	24/32	SMF, ME, H, HD, EMS
437612	68032 SMF	TT18	180	361	B	1100	513x222x194/221	B0	3	43,1	21/28	SMF, ME, H, HD, EMS
223612	70027 SMF	TT20	200	409	C	1200	517x275x214/241	B0	3	52,7	18/24	SMF, ME, H, HD, EMS
125612	72527 SMF	TT22	225	469	C	1300	517x275x214/241	B0	3	56,1	18/24	SMF, ME, H, HD, EMS

**TOPLA TOP** utilises the latest innovations in Ca/Ca manufacturing technology, providing for the highest cold start performance and superior reliable power as demanded by the latest generation of cars with high energy drain. The SMF lid/cover provides complete roll over spill protection and is entirely maintenance free throughout the batteries life.

- + Sealed cover construction
- + Higher number of plates ensure 30% better starting capabilities
- + The expanded metal technology results in better corrosion resistance and providing a longer life time
- + The level indicator (magic eye) provides an instant status check
- + Explosion protection prevents flame brake-in into the battery
- + Ideal for cars with lots of electrical equipment
- + Battery of highest quality



## TOPLA TOP

Flooded starter batteries, Ca/Ca technology | CAR batteries

ID	DIN marking	Short code	C20 (Ah)	RC (min)	Box type	EN (A)	L×W×H (mm)	BHD	Layout	Weight (kg)	PCS/Pallet (EUR/CNT)	Remarks
118654	55401 SMF	TT54	54	88	L1B	510	207×175×175	B13	0	12,3	72/120	SMF, ME, H
118655	55510 SMF	TT55H	55	90	L1	560	207×175×190	B13	0	12,8	72/100	SMF, ME, H
118662	56249 SMF	TT62	62	104	L2B	600	242×175×175	B13	0	13,9	63/108	SMF, ME, H
118666	56649 SMF	TT66H	66	112	L2	640	242×175×190	B13	0	15,0	63/90	SMF, ME, H
118072	57510 SMF	TT75	75	130	L3B	720	278×175×175	B13	0	16,5	51/80	SMF, ME, H, HD
118678	57549 SMF	TT78H	78	135	L3	750	278×175×190	B13	0	17,5	51/80	SMF, ME, H, HD
118685	58514 SMF	TT85	85	150	L4B	800	315×175×175	B13	0	18,9	42/72	SMF, ME, H, HD
118800	60044 SMF	TT100	100	182	L5	920	353×175×190	B13	0	22,5	36/60	SMF, ME, H, HD
118690	BCI 31P SMF	TT90BCIP	90	161	BCI 31	800	330×173×218/239	B1	0	23,4	42/60	SMF, ME, H, HD, P
118000	BCI 31S SMF	TT100BCIS	100	182	BCI 31	900	330×173×218/239	B1	0	24,3	42/60	SMF, ME, H, HD, S
118610	BCI31S SMF-D	TT110BCID	110	203	BCI 31	1000	330×173×218/237	B1	0	26,2	42/60	SMF, ME, H, HD, DP

## TOPLA TOP JIS

Flooded starter batteries, Ca/Ca technology | CAR batteries

ID	DIN marking	JIS marking (old/new)	Short code	C20 (Ah)	RC (min)	Box type	EN (A)	L×W×H (mm)	BHD	Layout	Weight (kg)	PCS/Pallet (EUR/CNT)	Remarks
118835	53520 SMF	NS40ZL SMF, 36B20L SMF	TT35J	35	53	53520	270	196×128×202/223	B0	0	9,4	96/128	SMF, H, JIS
118935	53522 SMF	NS40Z SMF, 36B20R SMF	TT35JX	35	53	53522	270	196×128×202/223	B0	1	9,4	96/128	SMF, H, JIS
118735	53520 SMF	NS40ZL SMF, 36B20L SMF	TT35JP	35	53	53520	270	196×134×202/223	B01	0	9,4	96/128	SMF, H, JIS
118245	54520 SMF	NS60LS BHD	TT45J	45	71	53520	360	196×134×202/223	B01	0	10,6	72/96	SMF, H, JIS
118145	54522 SMF	NS60S BHD	TT45JX	45	71	53522	360	196×134×202/223	B01	1	10,6	72/96	SMF, H, JIS
118845	54523/84 SMF	NS60LS SMF, 46B24LS SMF	TT45JA	45	71	54523/84	360	236×128×202/223	B0	0	11,9	72/96	SMF, H, JIS, A
118945	54524/51 SMF	NS60S SMF, 46B24RS SMF	TT45JAX	45	71	54524/51	360	236×128×202/223	B0	1	11,9	72/96	SMF, H, JIS, A
118255	55523/84 SMF		TT55J	55	90	54523/84	490	236×128×202/223	B0	0	13,5	72/96	SMF, H, JIS, A
118355	55524/51 SMF		TT55JX	55	90	54524/51	490	236×128×202/223	B0	1	13,5	72/96	SMF, H, JIS, A
118861	56068 SMF	N50ZL SMF, 55D23L SMF	TT60J	60	100	56068	600	230×173×200/220	B01	0	14,9	60/90	SMF, ME, H
118960	56069 SMF	N50Z SMF, 55D23R SMF	TT60JX	60	100	56069	600	230×173×200/220	B01	1	14,9	60/90	SMF, ME, H
118667	56568 SMF		TT65J	65	110	56068	650	230×173×200/220	B01	0	15,5	60/90	SMF, ME, H
118765	56569 SMF		TT65JX	65	110	56069	600	230×173×200/220	B01	1	17,1	60/90	SMF, ME, H
118870	57029 SMF	NS70L SMF, 65D26L SMF	TT70J	70	120	57029	700	259×175×200/221	B1	0	17,3	48/80	SMF, ME, H
118970	57024 SMF	NS70 SMF, 65D26R SMF	TT70JX	70	120	57024	700	259×175×200/221	B1	1	17,3	48/80	SMF, ME, H
118875	57529 SMF		TT75J	75	130	57029	740	259×175×200/221	B1	0	17,8	48/80	SMF, ME, H
118975	57524 SMF		TT75JX	75	130	57024	740	259×175×200/221	B1	1	17,8	48/80	SMF, ME, H
118895	59518 SMF	NX120-7L SMF, 105D31L SMF	TT95J	95	171	59518	850	306×173×200/221	B01	0	20,9	42/70	SMF, ME, H
118995	59519 SMF	NX120-7 SMF, 105D31R SMF	TT95JX	95	171	59519	850	306×173×200/221	B01	1	20,9	42/70	SMF, ME, H

# OUR CONTRIBUTION T



**TOPLA EFB Stop & Go** batteries are so called Enhanced Flooded Batteries intended for use in vehicles with entry level Start-Stop function. EFB batteries utilize the latest innovations in Ca/Ca flooded battery manufacturing technology, providing for the superior reliable power as demanded by the latest generation of cars with entry level Start-Stop system.

- + MFW fleece on positive plates, preventing active material shedding boast twice as much cyclic capability as standard batteries and can be more discharged without any loss of functionality
- + Improved charge acceptance for recovering energy more quickly during driving phase using special expander with carbon
- + The expanded metal technology results in better corrosion resistance providing a longer life time
- + Sealed cover construction, roll over proof
- + Maintenance free
- + The level indicator (magic eye) provides an instant status check
- + Explosion protection with flame arrestor



## TOPLA EFB Stop & Go

EFB starter batteries, Ca/Ca technology | CAR batteries

ID	DIN marking	JIS marking (old/new)	Short code	C20 (Ah)	RC (min)	Box type	EN (A)	LxWxH (mm)	BHD	Layout	Weight (kg)	PCS/Pallet (EUR/CNT)	Remarks
112260	56068 SMF	N50ZL SMF, 55D23L SMF	TSG60J	60	100	56068	600	230x173x200/220	B01	0	17,1	60/90	SMF, ME, H
112160	56069 SMF	N50Z SMF, 55D23R SMF	TSG60JX	60	100	56069	600	230x173x200/220	B01	1	17,1	60/90	SMF, ME, H
112060	56088 SMF		TSG60	60	100	L2	580	242x175x190	B13	0	16,6	63/90	SMF, ME, H
112065	56588 SMF		TSG65	65	110	L3B	650	278x175x175	B13	0	16,5	51/80	SMF, ME, H, HD
112070	57088 SMF		TSG70	70	120	L3	680	278x175x190	B13	0	19,2	51/80	SMF, ME, H, HD
112080	58088 SMF		TSG80	80	140	L4	760	315x175x190	B13	0	21,9	42/60	SMF, ME, H, HD
112090	59088 SMF		TSG90	90	161	L5	850	353x175x190	B13	0	24,6	36/60	SMF, ME, H, HD
112005	60518 SMF	NX120-7L SMF, 105D31L SMF	TSG10J	105	192	59518	900	306x173x200/221	B01	0	23,3	42/70	SMF, ME, H
112105	60519 SMF	NX120-7 SMF, 105D31R SMF	TSG10JX	105	192	59519	900	306x173x200/221	B01	1	23,3	42/70	SMF, ME, H
491612	69032 SMF		TSG19	190	385	B	1100	513x222x194/221	B0	3	45,3	21/28	SMF, ME, H, HD, EMS
454612	74027 SMF		TSG24	240	506	C	1250	517x275x214/241	B0	3	58,6	18/24	SMF, ME, H, HD, EMS

# 0 LOW CO<sub>2</sub> EMISSIONS



**TOPLA AGM Stop & Go** batteries are Valve Regulated Lead Acid batteries intended for use in vehicles with enhanced level Start-Stop function with break energy recuperation. VRLA AGM battery is improved lead acid battery to its maximum performance. The battery cells are closed by a pressure relief valve and electrolyte is immobilized in absorbed glass mat (AGM). Plate stacks are kept in the cells under pressure.

THE ADVANCED CONSTRUCTION OF BATTERY LEADS TO IMPROVED PERFORMANCE IN:

- + Very low water consumption due to internal oxygen recombination,
- + Preventing active material shedding boast more than three times as much cyclic capability as standard batteries and can be more discharged without any loss of functionality
- + Increased cranking power due to better utilization of cell volume by more than 30 %
- + High rate charge acceptance for recovering energy more quickly during driving phase
- + Both side pasting of plates provides better corrosion resistance providing a longer life time
- + No acid stratification like in flooded cells
- + Explosive safe - minimum explosive gasses are produced
- + Vibration resistance and no acid leakage in case of crash



## TOPLA AGM Stop & Go

AGM starter batteries, Ca/Ca technology | CAR batteries

ID	DIN marking	Short code	C20 (Ah)	RC (min)	Box type	EN (A)	L×W×H (mm)	BHD	Layout	Weight (kg)	PCS/Pallet (EUR/CNT)	Remarks
114060	L2 AGM	TAG60	60	109	L2	680	242×175×190	B13	0	17,9	63/90	AGM, H
114070	L3 AGM	TAG70	70	130	L3	760	278×175×190	B13	0	20,5	48/80	AGM, H
114080	L4 AGM	TAG80	80	151	L4	800	315×175×190	B13	0	23,2	42/60	AGM, H
114090	L5 AGM	TAG95	95	184	L5	850	353×175×190	B13	0	26,0	36/60	AGM, H
114105	L6 AGM	TAG105	105	206	L6	950	394×175×190	B13	0	29,2	36/60	AGM, H

